

COMPAL CONFIDENTIAL

MODEL NAME: HBQ60
PCB NAME: LS-2925P AUDIO/B
COMPAL P/N: DA200005N00
REVISION: 0.2
DATE: 2005/11/23

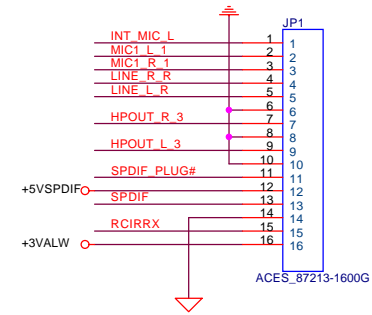

S/PDIF Out JACK

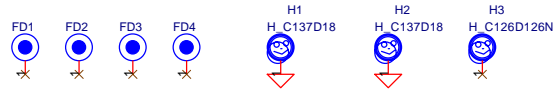
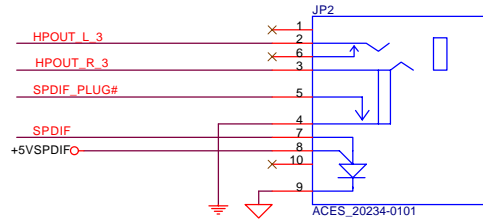

LINE-IN JACK

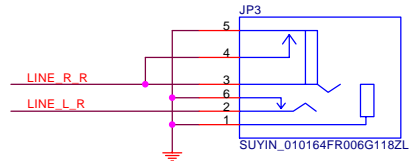

MIC JACK

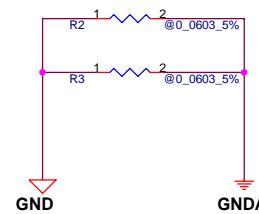
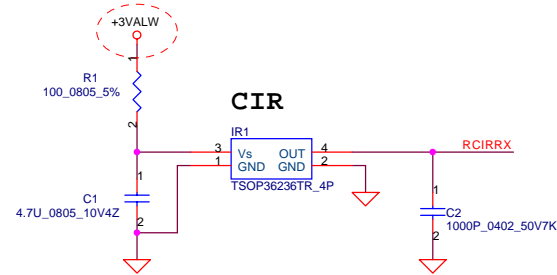
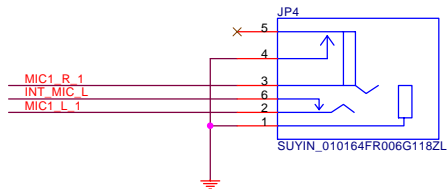

Security Classification	Compal Secret Data			Compal Electronics, Inc.		
Issued Date	2005/06/20	Deciphered Date	2006/06/20	Title AUDIO/B		
THIS SHEET OF ENGINEERING DRAWING IS THE PROPRIETARY PROPERTY OF COMPAL ELECTRONICS, INC. AND CONTAINS CONFIDENTIAL AND TRADE SECRET INFORMATION. THIS SHEET MAY NOT BE TRANSFERRED FROM THE CUSTODY OF THE COMPETENT DIVISION OF R&D DEPARTMENT EXCEPT AS AUTHORIZED BY COMPAL ELECTRONICS, INC. NEITHER THIS SHEET NOR THE INFORMATION IT CONTAINS MAY BE USED BY OR DISCLOSED TO ANY THIRD PARTY WITHOUT PRIOR WRITTEN CONSENT OF COMPAL ELECTRONICS, INC.				Size Custom	Document Number HBQ60 LS-2925P	Rev 0.2
Date:	Tuesday, November 29, 2005	Sheet	1 of 1			